

Aerfoam 200 Bend 30°



ubblink

Build smart.

Article number: 188229

Product introduction

Aerfoam is an easy-to-install, insulated and airtight ductwork system used in central mechanical ventilation and heat pump systems, which minimises the risk of condensation in or on the duct (airtightness class D = ATC 2 up to +/- 200 Pa).

- Insulated
- Extremely easy and safe to cut to length
- Airtight mechanical connections, which are extremely easy to install
- Airtightness class D/ATC 2 up +/- 200 Pa, which minimises fan energy use and sound production
- EPD certified and REACH compliant

Product dimensions

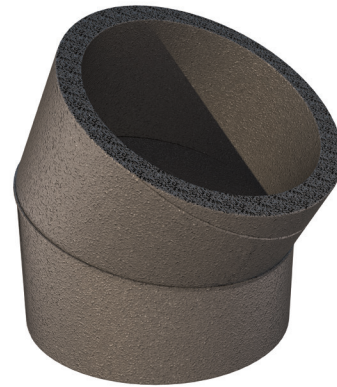
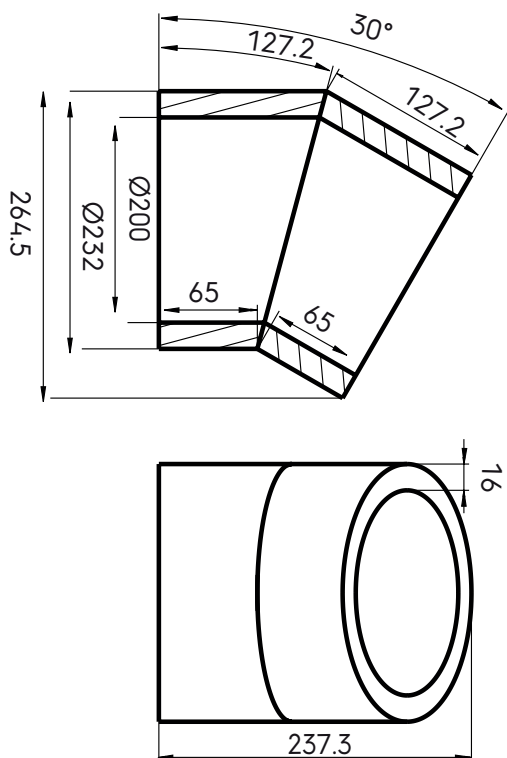

Application

- Ventilation
- Heating (Air)
- Cooling (Air)

Aerfoam 200 Bend 30°

Article number: 188229

Technical specifications

Technical	
Colour	Grey
Insulated	<input checked="" type="checkbox"/>
Diameter inner	200 mm
Diameter outer	232 mm
Insulation thickness	16 mm
Performance	
Insulation performance	0.041 W/m.K
Temperature resistance (min.)	-30 °C
Temperature resistance (max.)	60 °C
Installation temperature (min.)	-30 °C
Installation temperature (max.)	60 °C
Zeta supply 1 connection	0.22
Zeta extract 1 connection	0.22
Dimensions	
Length gross	265 mm
Width	232 mm
Height	238 mm
Net weight	0.07 kg