

Air Excellent AE34C Connector

Article number: 188350

Product introduction

An AE34C duct accessory used to connect AE34C ducts. Use 2 AE34C seal rings and 2 AE34C click rings to connect the ducts to it.

- Modular manifolds, which can be used with all 6 duct types
- Semi-rigid plastic ducts on a roll and airtight mechanical connections, which are extremely easy to install
- Low system pressure loss due to radial design
- Airtight (class D/ATC 2 up +/- 2000 Pa) thanks to mechanical connections, which minimises fan energy use and sound production
- TÜV SÜD and ISEGA tested and certified, REACH compliant

Product dimensions

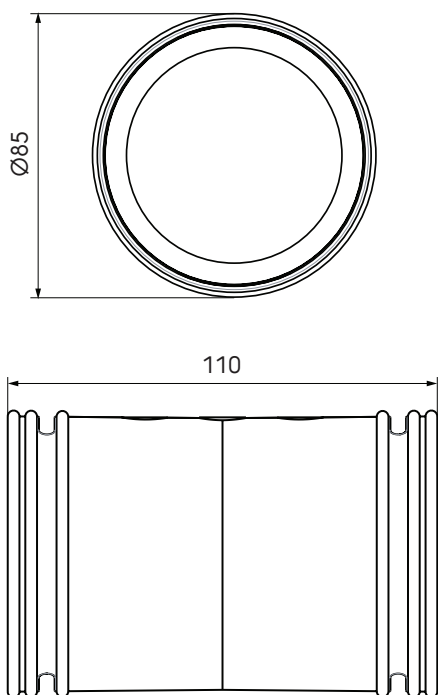

Performance

Airtightness Class D for Air Excellent ductwork, Air Excellent ductwork accessories and the Air Excellent plastic distribution boxes. Tested according to TÜV SÜD Standard TAK 01-2013 (system pressure: + 2000 Pa/- 2000 Pa)

Air Excellent AE34C Connector

Article number: 188350

Technical specifications

Specifications	
Technical	
Colour	Green
Material	PP
Anti static	<input checked="" type="checkbox"/>
Antimicrobial	<input checked="" type="checkbox"/>
Performance	
Temperature resistance (min.)	-20 °C
Temperature resistance (max.)	60 °C
Reaction to fire: Euro class	E
Dimensions	
Length gross	110 mm
Width	85 mm
Height	85 mm
Net weight	0.04 kg