

Air Excellent DBOX 808

Article number: 188583

Product introduction

Air Excellent distribution box to which all Air Excellent duct types can be connected.

- Modular manifolds, which can be used with all 6 duct types
- Semi-rigid plastic ducts on a roll and airtight mechanical connections, which are extremely easy to install
- Low system pressure loss due to radial design
- Airtight (class D/ATC 2 up +/- 2000 Pa) thanks to mechanical connections, which minimises fan energy use and sound production
- TÜV SÜD and ISEGA tested and certified, REACH compliant

Product dimensions

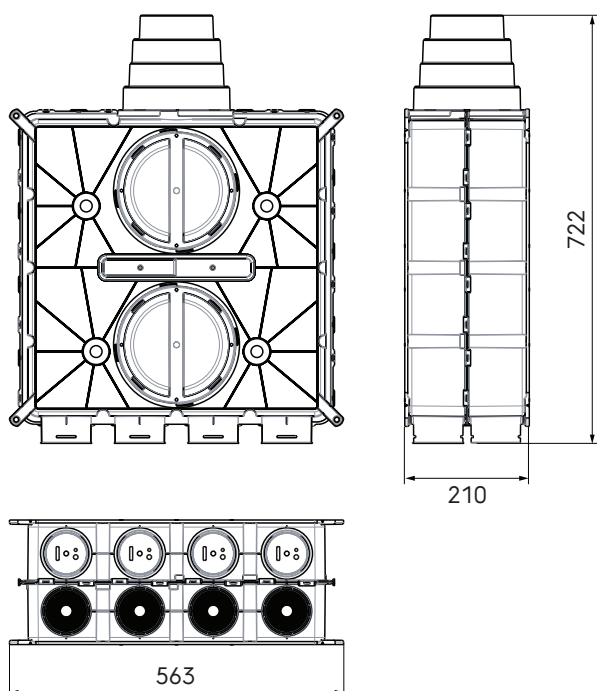

Performance

Airtightness Class D for Air Excellent ductwork, Air Excellent ductwork accessories and the Air Excellent plastic distribution boxes. Tested according to TÜV SÜD Standard TAK 01-2013 (system pressure: + 2000 Pa/- 2000 Pa)

Air Excellent DBOX 808

Article number: 188583

Technical specifications

Specifications	
Technical	
Colour	Grey
Material	PP
Anti static	<input checked="" type="checkbox"/>
Antimicrobial	<input checked="" type="checkbox"/>
Performance	
Temperature resistance (min.)	-20 °C
Temperature resistance (max.)	60 °C
Reaction to fire: Euro class	E
Dimensions	
Length gross	722 mm
Width	592 mm
Height	210 mm
Net weight	3.07 kg

Technical details

Pressure Loss Dbox	
Qv (Volume) [m³/h]	Δp (Pressure Loss) [Pa]
50	0,2
100	0,8
150	1,6
200	2,7
250	4,0
300	5,7
350	7,6
400	9,8
450	12,3
500	15,1
550	18,2
600	21,5
650	25,2
700	29,1
750	33,3
800	37,8

Figures are based on measurements by the TÜV SÜD.