

Air Excellent AE34C Connector Kit

Article number: 188993

Product introduction

The AE34C Connector Kit seamlessly connects two AE34C ducts, ensuring a quick, secure and tool-free installation. Includes two AE34C Click-Seal Rings.

- Airtight connections for reliable system performance
- Low pressure loss to reduce fan energy use
- Quick, tool-free installation
- Lightweight design for easy handling
- TÜV SÜD-certified for quality and safety

Product dimensions

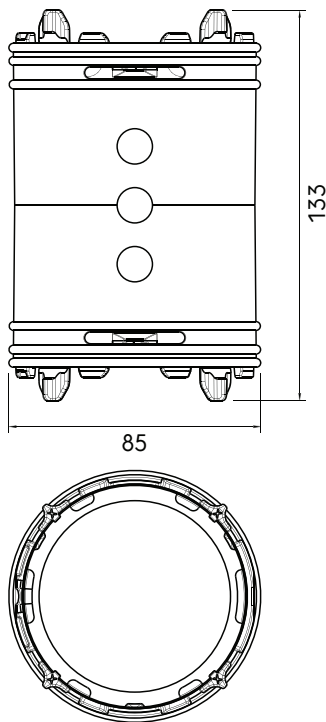

Kit content

To be defined

Technical specifications

Technical	
Colour	Green
Anti static	<input checked="" type="checkbox"/>
Antimicrobial	<input checked="" type="checkbox"/>
Performance	
Temperature resistance (min.)	-20 °C

Air Excellent AE34C Connector Kit

Article number: 188993

Technical specifications (continuation)

Performance	
Temperature resistance (max.)	60 °C
Reaction to fire: Euro class	E
Zeta supply 1 connection	0
Zeta extract 1 connection	0
Dimensions	
Length gross	133 mm
Width	85 mm
Height	85 mm
Net weight	0.075 kg