

Aerfoam 180 Bend 15°

Article number: 188280

Product overview

The Aerfoam 180 mm 15° bend allows directional changes within the Aerfoam system. Made of expanded polyethylene (EPE) duct, it minimises the risk of condensation and energy loss. It is very light and extremely easy and safe to install. All Aerfoam parts connect to each other using strong, airtight mechanical connections. They can also be securely mounted to walls or ceilings using brackets. Aerfoam is ideal for both central mechanical ventilation and domestic hot water heat pump systems.

- Insulated to minimise the risk of condensation and energy loss.
- Easy mechanical connection and mounting.
- Lightweight and easy to cut, ensuring quick installation.
- Impact resistant.

Product dimensions

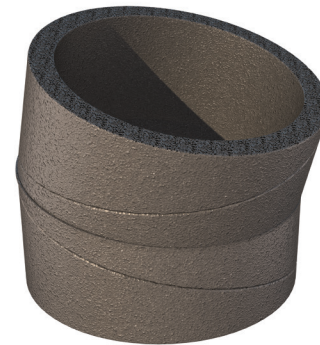
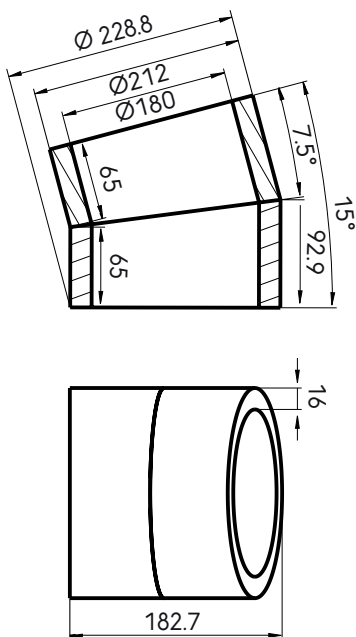

Aerfoam 180 Bend 15°

Article number: 188280

Technical specifications

Technical	
Colour	Grey
Insulated	<input checked="" type="checkbox"/>
Diameter inner	180 mm
Diameter outer	212 mm
Insulation thickness	16 mm
Performance	
Insulation performance	0.041 W/m.K
Temperature resistance (min.)	-30 °C
Temperature resistance (max.)	60 °C
Installation temperature (min.)	-30 °C
Installation temperature (max.)	60 °C
Zeta supply 1 connection	0.4
Zeta extract 1 connection	0.4
Dimensions	
Length gross	228 mm
Width	212 mm
Height	183 mm
Net weight	0.04 kg

Aerfoam 180 Bend 15°

Article number: 188280

Technical details

DN180 15° Bend		
Zeta [-]	0,17	
Qv [m³/h]	Δp [Pa]	V [m/s]
50	0,03	0,55
100	0,12	1,09
150	0,27	1,64
200	0,49	2,18
250	0,76	2,73
300	1,09	3,27
350	1,49	3,82
400	1,94	4,37
450	2,46	4,91
500	3,04	5,46
550	3,68	6
600	4,38	6,55
650	5,14	7,1
700	5,96	7,64