

# Air Excellent AE35SC DBOX Adaptor

Article number: 188554

## Product introduction

An AE35SC duct accessory used to connect a AE35SC duct to a distribution box.

- Modular manifolds, which can be used with all 6 duct types
- Semi-rigid plastic ducts on a roll and airtight mechanical connections, which are extremely easy to install
- Low system pressure loss due to radial design
- Airtight (class D/ATC 2 up +/- 2000 Pa) thanks to mechanical connections, which minimises fan energy use and sound production
- TÜV SÜD and ISEGA tested and certified, REACH compliant

## Product dimensions

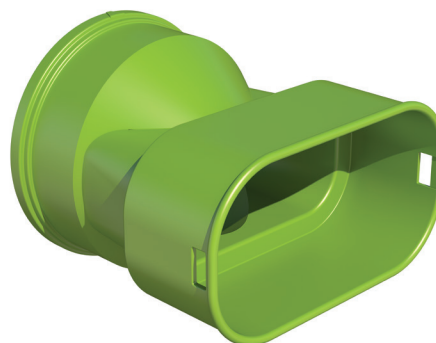
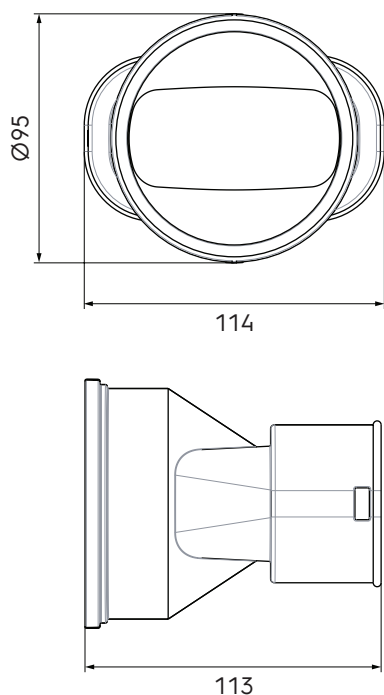

## Technical specifications

Specifications	
Technical	
Colour	Green
Material	Plastic
Anti static	<input checked="" type="checkbox"/>
Antimicrobial	<input checked="" type="checkbox"/>

# Air Excellent AE35SC DBOX Adaptor

Article number: 188554

## Technical specifications (continuation)

Performance	
Temperature resistance (min.)	-20 °C
Temperature resistance (max.)	60 °C
Reaction to fire: Euro class	E
Dimensions	
Length gross	113 mm
Width	114 mm
Height	95 mm
Net weight	0.08 kg